

Q-bao
OUTDOOR KITCHENS

OUTDOOR
KITCHEN



Premium outdoor kitchens without limits

2026



Contents

ABOUT Q-BOO	02
OUR CRAFTSMANSHIP	06
THE MODULAR SYSTEM	12
FINISH OPTIONS	16
RESISTANT MATERIALS	17
BBQ MODULE	24
EGG MODULE	26
SINK MODULE	28
BURNER MODULES	30
FRIDGE & ICE MAKER	32
CABINET MODULES	34
CORNER MODULE	36
ISLA KITCHEN ISLAND	40
OUTDOOR FIREPLACES	42
Q-BOO DESIGN TEAM	48

about us

Q-boo was born from a love of fire and the way it brings people together.

We come from Planika — a global leader in modern fire solutions — where design meets technology to create warmth that's clean, safe, and beautiful. Q-boo takes that experience outdoors.

Crafted in Europe, built from the ground up, Q-boo creates a space — for late dinners, open skies, shared bottles, and stories that last longer than the evening itself.

We chose modularity for a reason. Every space is different, every gathering its own. That's why Q-boo kitchens are made to adapt — to terraces, gardens, rooftops, and the way you like to cook and connect. Durable materials, clean lines, effortless function — nothing is accidental.

From rooftops in London to desert resorts in the Middle East, Q-boo lives where people live fully.

Not for those who worry about a drop of wine on the counter — but for those who raise their glasses and keep the fire going.

Q-boo. Made for cooking. Built for life.

 [instagram.com/qboo.outdoor/](https://www.instagram.com/qboo.outdoor/)

 [youtube.com/@Q-boo_outdoor](https://www.youtube.com/@Q-boo_outdoor)

 [linkedin.com/company/q-boo-outdoor](https://www.linkedin.com/company/q-boo-outdoor)

 [pinterest.com/qbookitchen/](https://www.pinterest.com/qbookitchen/)



„An outdoor dining experience is where luxury meets nature,
and every meal becomes a cherished memory.“

Q-boo



—
„An outdoor
kitchen
transforms
meals into
moments,
where laughter
and love are
the main
ingredients.”



CRAFTED TO ENDURE.
DESIGNED TO IMPRESS

OUR CRAFTSMANSHIP

OVER 20 YEARS OF EXPERTISE

We've spent over two decades working with steel — starting with premium outdoor fireplaces, now brought into the world of high-end kitchens. With more than 40 000 outdoor units sold worldwide, we know what it takes to build products that last. That experience lives in every Q-boo kitchen. Every line is intentional. Every material is chosen. And every Q-boo is made in our own European factory — where no detail is left to chance.

BUILT FOR THE OUTDOORS

Crafted from materials that defy the elements, Q-boo kitchens are made to thrive under open skies. The structure is forged in 304 stainless steel — solid, weatherproof, unshaken by time. For sink and grill elements, we use Marine Grade 316 — trusted in shipbuilding, chosen for its strength against salt and corrosion. And with Dekton surfaces, the kitchen stands firm against heat, rain, sun, and sea breeze — beautiful, durable, and ready for any season.

SET UP IN NO TIME

We've taken the complexity out of outdoor kitchens. No builders, no weeks of construction. Just clean, intelligent design — modular units that click into place and form a complete system.

From delivery to first use, it's a seamless process built for simplicity — because time outside should be spent living, not installing.

PROTECTED FOR YEARS

A kitchen built to last should come with a promise. That's why the Q-boo is backed by a 10-year warranty — a quiet reassurance that real quality doesn't rush or fade. It's made to stay with you — through changing seasons, long summers, and years of shared moments.



250cm STONE Collection (98 7/16")

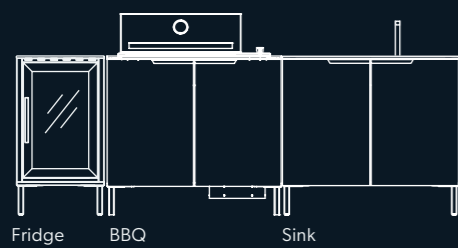

SEE THIS
CONFIGURATION IN AR



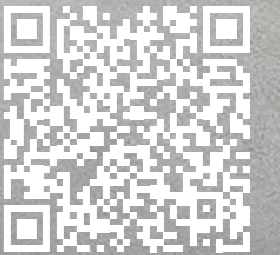

SEE THIS
CONFIGURATION IN AR

Twelve modules

Endless ways to make them yours

Q-boo offers a set of modular units that you can combine your way — to suit your space, your cooking style, and how you like to spend time outdoors.



SEE OUR KITCHEN CONFIGURATOR

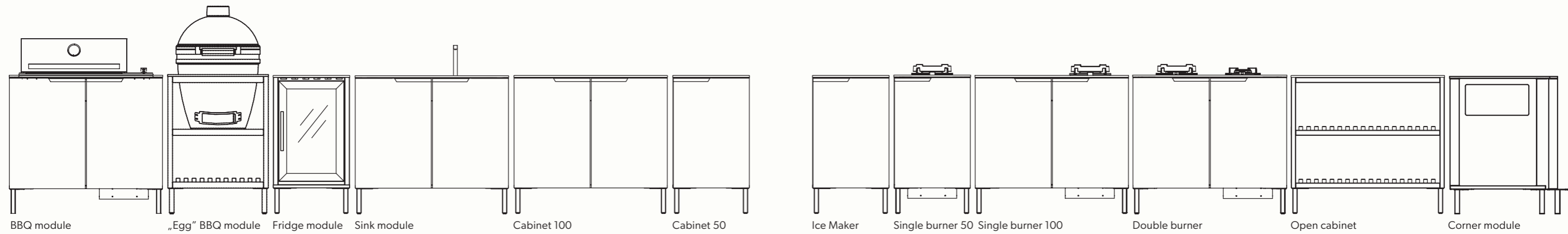

SEE THIS CONFIGURATION IN AR



SEE THIS
CONFIGURATION IN AR

What it is made of matters

Outdoor kitchens don't get the comfort of walls — so the materials matter.

We use Dekton by Cosentino and stainless steel because they're made to handle rain, sun, heat, and time.

You can choose from a curated selection of tones and finishes — from sleek steel to textured surfaces and natural stone effects.

It's about finding the right feel for your space, without compromising on durability.

Available finishes

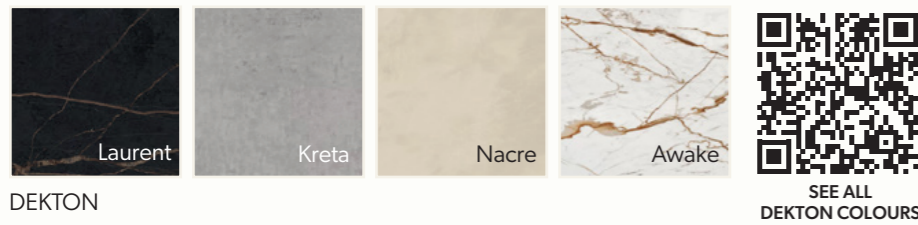

DEKTON



FLUSH STEEL

WAVED STEEL



ANY RAL COLOUR ON REQUEST

- BACK CLADDING**
- Smooth steel
 - **Optional 4 mm Dekton**

- SIDE CLADDING**
- Flush steel
 - **Optional 4 mm Dekton**



- COUNTERTOP**
- 12 mm Dekton

- DOOR CLADDING**
- 4 mm Dekton
 - Flush steel
 - Waved steel

Some materials just don't quit

We work with materials proven to withstand outdoor conditions. Dekton by Cosentino is stain-resistant, easy to clean, and holds its color for years. The most exposed elements are made from stainless steel 316 — the same grade used in marine environments.

And for open cabinet shelves, we use Iroko wood: dense, weather-resistant, and naturally beautiful. **Whatever the climate, the materials are ready.**



RESISTANCE TO SCRATCHES, ABRASION, AND IMPACTS



HIGH-TEMPERATURE AND FIRE RESISTANCE



STAIN RESISTANCE



WATER RESISTANCE



EASE OF CLEANING



UV RESISTANCE

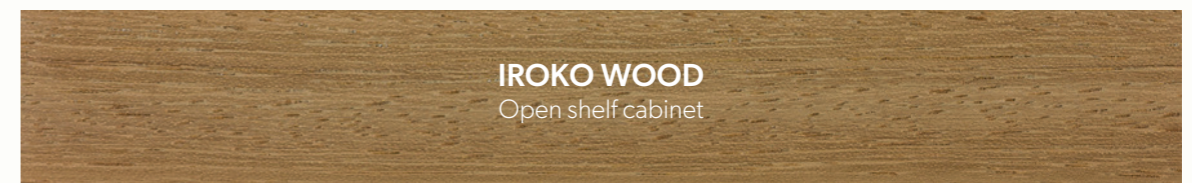

IROKO WOOD
Open shelf cabinet

„Design your outdoors for the people
and moments that matter.”



SEE THIS
CONFIGURATION IN AR

315 cm LINE Collection (124")

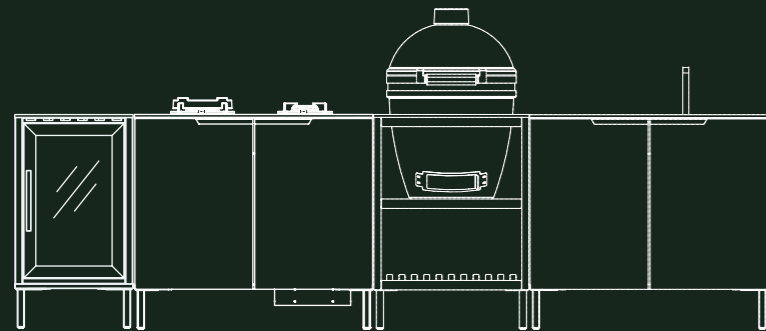

Fridge Double burner „Egg” BBQ module Sink module



SEE THIS CONFIGURATION IN AR





SEE THIS
CONFIGURATION IN AR

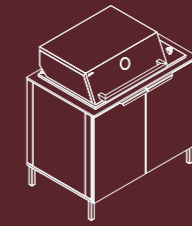

BBQ MODULE

Cooking outside should feel as natural as indoors — just with better air. Made of **Marine Grade 316 stainless steel**, the BBQ module is built to perform in coastal climates and open spaces alike — solid, reliable, and made for long seasons outdoors.

Three burners give you full temperature control through individual gauges. Flame tamers and a grease tray make cleaning simple. The module also includes storage space for an **8-11kg/20-24 lb gas cylinder** — right where you need it, without taking up extra room. For even more versatility, it can be fitted with **teppanyaki plates**, perfect for grilling seafood, vegetables, or delicate cuts that benefit from a flat cooking surface. Everything's designed to keep the focus where it belongs — on the food, and the people around it.



SEE VIDEO

Fuel type	Propane / LPG / GPL
Max. gas cylinder dimensions	H 600 mm x Ø300 mm
Heat output	3 burners 4.0 kW / 13 600 BTU each
Gas consumption	3,06 kg/h / 6.75 lbs/h
Gas pressure	(LPG) 37 mbar / 14.9 inWC
Cooking area dimensions	780x490 mm / 30 11/16" in x 19 5/16"
Flame height regulation	Yes
Weight	~75 kg / ~165 lbs

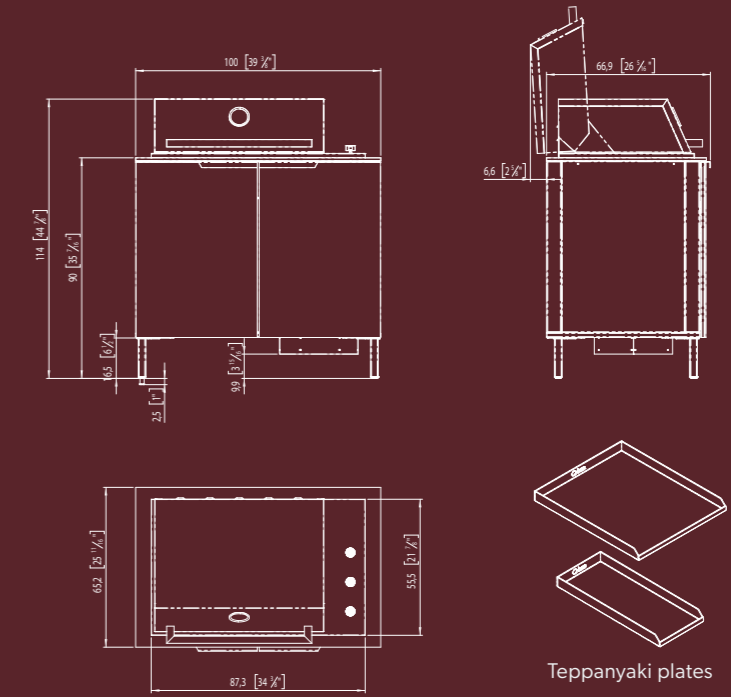

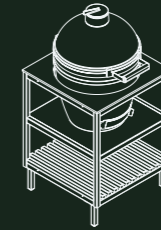

„EGG“ BBQ MODULE

For those who love slow cooking and smoky flavors, the Egg BBQ Module is built to hold a **Big Green Egg size L** securely and at the right working height. Made from weather-resistant stainless steel and finished with Dekton to match the rest of the Q-boo kitchen, it integrates the ceramic grill into a clean, modular setup. A side shelf in **Iroko wood** provides natural warmth and extra storage space. Durable, stable, and ready for long outdoor cooking sessions.

Big Green Egg size	Max. L
Weight	~34 kg / ~75 lbs

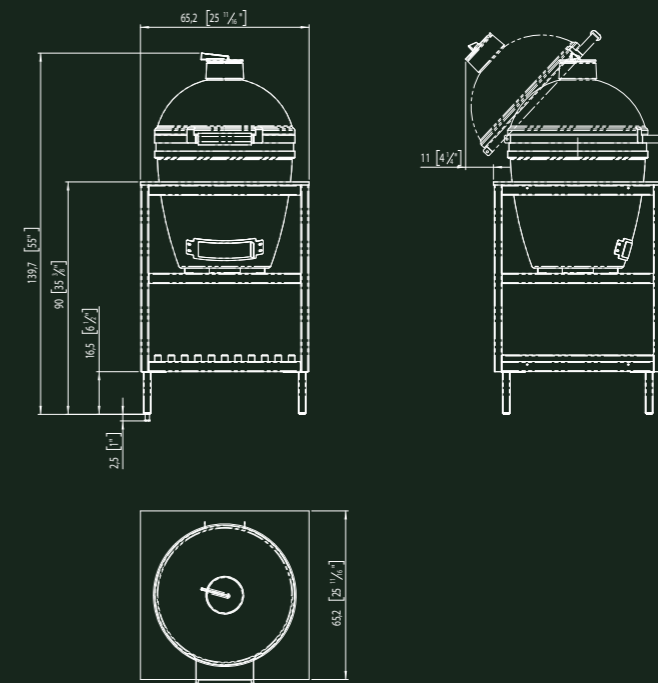

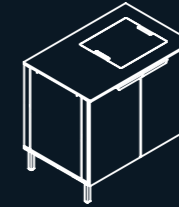

SINK MODULE

Washing up isn't the highlight of the evening — but it should never be a hassle.

The sink module includes a pull-up faucet, soap dispenser, and a smart layout with built-in waste and storage compartments. Made of **Marine Grade 316 stainless steel with a PVD coating**, it withstands coastal climates and keeps its refined look over time.

The integrated protective cover keeps the sink clean when not in use and creates additional prep space whenever needed. Made from Dekton — the same material as the countertop — it blends seamlessly with the surface for a clean, cohesive look.



SEE VIDEO

Sink dimensions	500 mm x 450 mm x 236mm / 19 1/16" x 17 1/16" x 9 5/16"
Weight	~75 kg / ~165 lbs

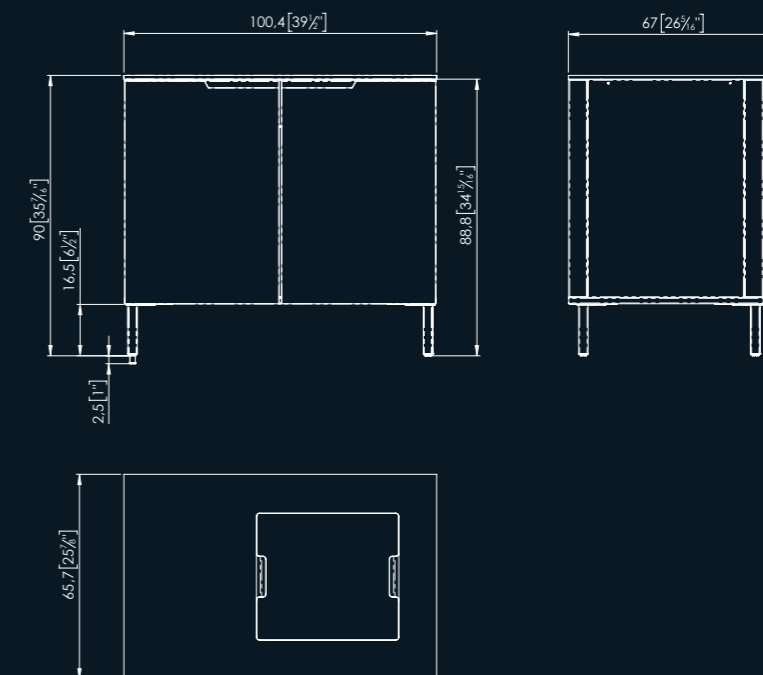

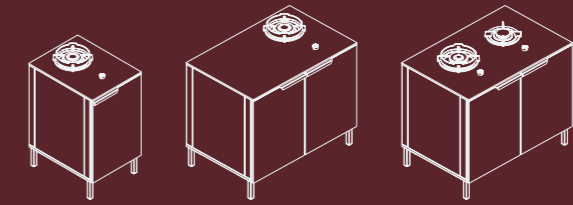

BURNER MODULES

Outdoor cooking doesn't stop at the grill. Our burner modules give you the flexibility to boil, simmer, sauté — whatever else the meal calls for.

They come in **three versions: wide or compact, with one or two burners**. All use high-quality components from a trusted Italian manufacturer, with **smooth flame control and reliable ignition**. **Gas storage for a 8-11kg/20-24 lb gas cylinder is integrated** into the module to keep things tidy and efficient. Perfect on their own — or right alongside the BBQ, when dinner calls for a little more.

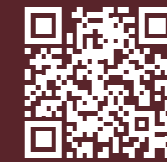

SEE VIDEO

Fuel type	propane / LPG / GPL
Max. gas cylinder dimensions	H 600 mm x Ø300 mm / 23 10/16" x 11 13/16"
Heat output	1. burner Ø 100 mm - 1,75 kW / 5 970 BTU/h 2. burner Ø 120 mm - 5,0 kW / 17 060 BTU/h
Gas consumption	1. burner Ø 100 mm - 0,14 kg/h / 0.3 lbs/h 2. burner Ø 120 mm - 0,39 kg/h / 0.9 lbs/h
Gas pressure	(LPG) 37 mbar / 14.9 inWC
Flame height regulation	Yes
Weight 100 module	~75 kg / ~165 lbs
Weight 50 module	~41 kg / ~90 lbs

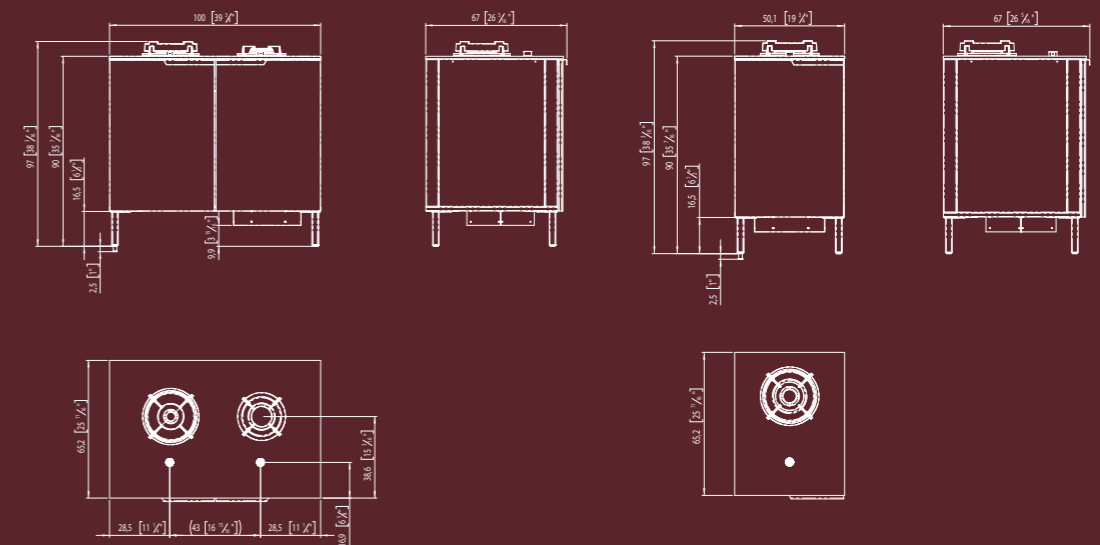

Single/Double burner module 100

Single burner module 50



SEE VIDEO

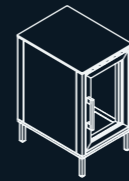

FRIDGE MODULE

Some things are better cold. The fridge module keeps drinks, sides, and ingredients at the right temperature — even in hot weather. We use a **Caso unit**, known for reliable performance in outdoor conditions. Built as a standalone 50 cm module, it fits neatly into any Q-boo configuration and adds the comfort of cold storage right where you need it. The interior is **LED-lit**, making it easy to find what you need — even after sunset.

Weight	~41 kg / ~90 lbs
Average daily energy consumption	0.945 kW/24h
Connection	220 V-240V; 50Hz; 04A
Capacity	63L
Splash water protection	IPX4

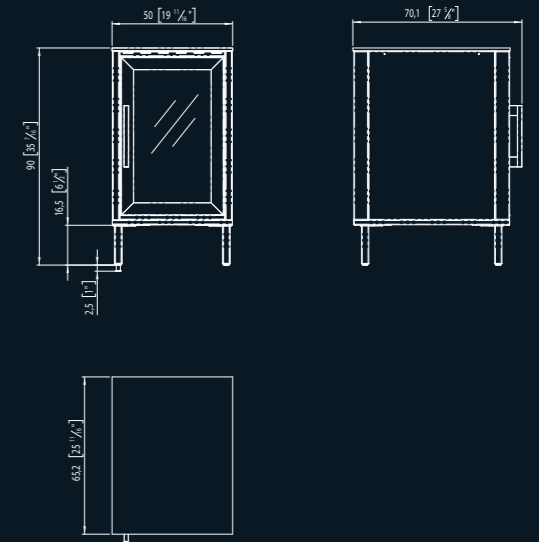

ICE MAKER MODULE

Cold drinks always within reach — without disrupting the clean look of your outdoor kitchen. The Ice Maker Module hides a high-performance ice machine inside a fully enclosed cabinet, preserving the seamless design of the entire setup.

Connected directly to the water supply, it works automatically with no need for manual refilling, producing up to 18 kg of ice per day.

Weight	~70 kg / ~154 lbs
Avg. daily energy consumption	6.4 kWh/24h
Connection	115V/60Hz; 230V/50Hz; 230V/60Hz water and draining connection
Capacity	4 kg
Ice production	18 kg/day

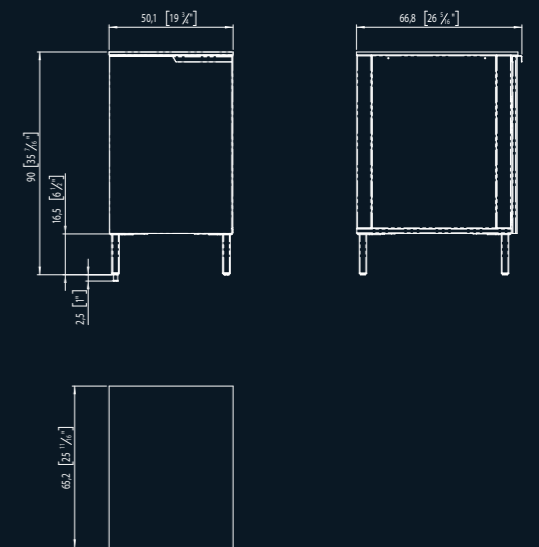

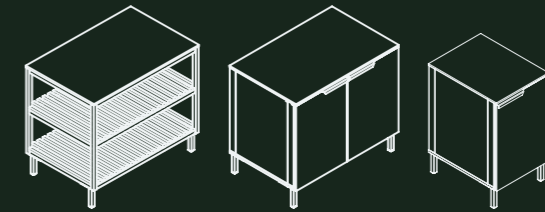

CABINET MODULES

A clean surface. Hidden storage. Or open shelving for your everyday essentials. These modules extend your workspace while keeping everything you need close at hand.

Available as full cabinets (100 cm and 50 cm) or with open **Iroko wood** shelves.

Magnetic door closure: strong built-in magnets keep the doors securely shut — no matter the weather.

Weight open cabinet ~52 kg / ~115 lbs

Weight cabinet 100 ~75 kg / ~165 lbs

Weight cabinet 50 ~41 kg / ~90 lbs

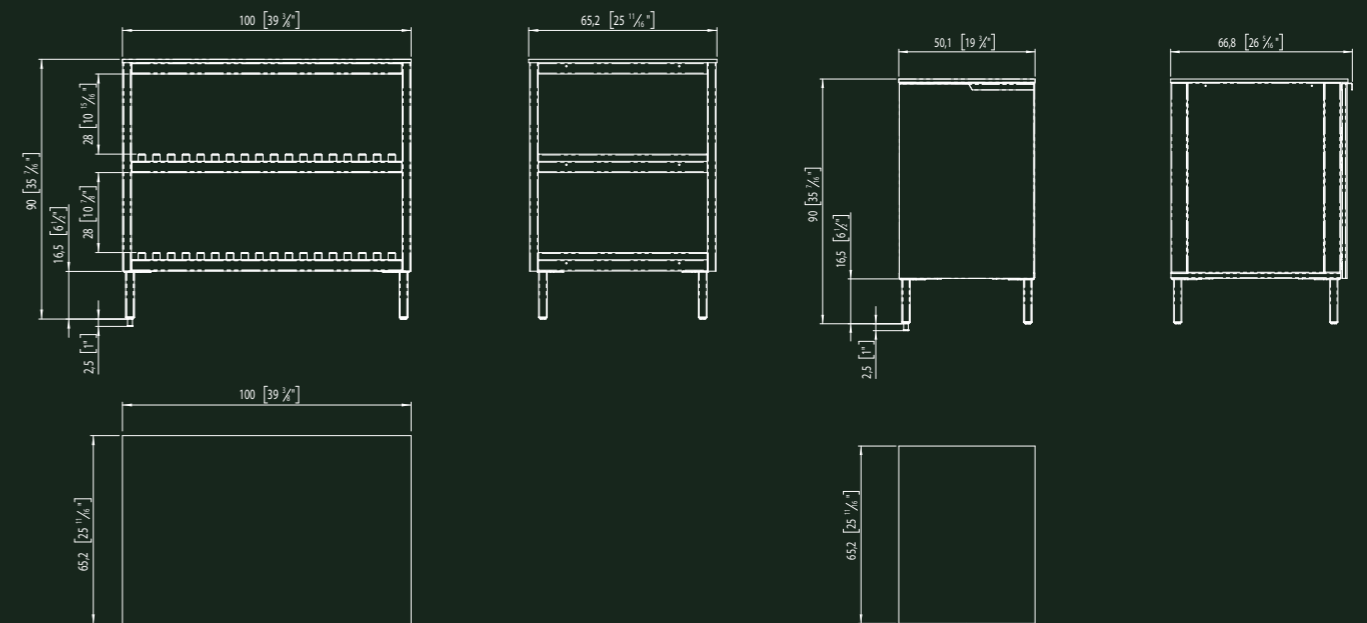

AVAILABLE ACCESSORIES - FOR ALL MODULES

Designed to keep your workspace organized and everything within reach.



3 Drawers set

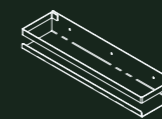

Kitchen rack

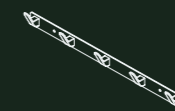

Hooks

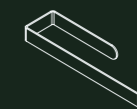

Towel hanger



Magnetic knife holder

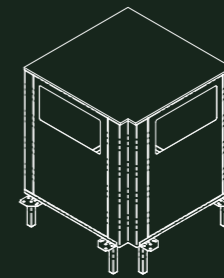

CORNER MODULE

A clean surface. Hidden storage. Or open shelving for your everyday essentials. These modules extend your workspace while keeping everything you need close at hand. Available as full cabinets (100 cm and 50 cm) or with open **Iroko wood** shelves.

Magnetic door closure: strong built-in magnets keep the doors securely shut — no matter the weather.

Weight open cabinet ~52 kg / ~115 lbs

Weight cabinet 100 ~75 kg / ~165 lbs

Weight cabinet 50 ~41 kg / ~90 lbs

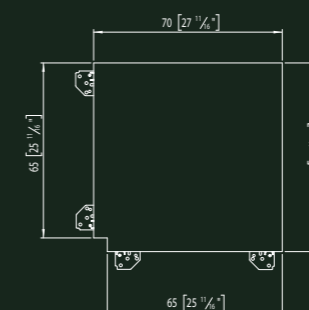
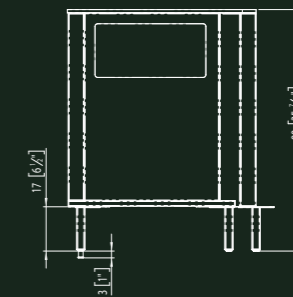
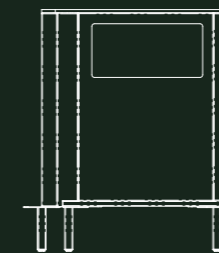

350cm WAVE Collection (137 13/16")

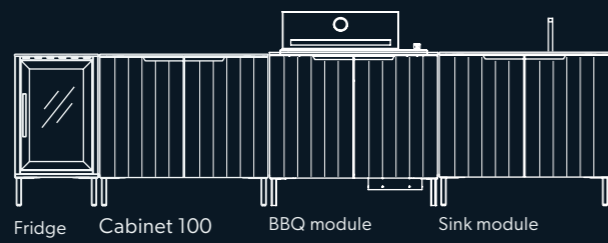

SEE THIS
CONFIGURATION IN AR



Isla Outdoor Kitchen

Functional island kitchen for your luxury outdoor space

Isla is a premium outdoor kitchen island designed as a fully accessible centerpiece, allowing comfortable use from all four sides. It combines durable materials like stainless steel and weather-resistant Dekton surfaces with a clean, architectural form suited for high-end outdoor spaces. The island integrates all key functions in one compact layout: a built-in grill, burner, sink w and a fridge — creating a complete outdoor cooking station that brings together preparation, cooking, and social interaction in a single, refined solution.

Fuel type	Propane / LPG / GPL
Max. gas cylinder dimensions	H 600 mm x Ø300 mm
Gas pressure	(LPG) 37 mbar / 14.9 inWC
BBQ gas consumption	3,06 kg/h / 6.75 lbs/h
BBQ heat output	3 burners 4.0 kW / 13 600 BTU each
BBQ cooking area	780x490 mm / 30 11/16" in x 19 5/16"
Burner heat output	Burner Ø 120 mm - 5,0 kW / 17 060 BTU/h
Burner gas consumption	0,39 kg/h / 0.9 lbs/h
Average daily energy consumption	0.945 kW/24h
Fridge connection	220 V-240V; 50Hz; 04A
Fridge capacity	63L
Sink dimensions	500 mm x 450 mm x 236mm / 19 11/16" x 17 11/16" x 9 5/16"
Weight	~356 kg / ~786 lbs

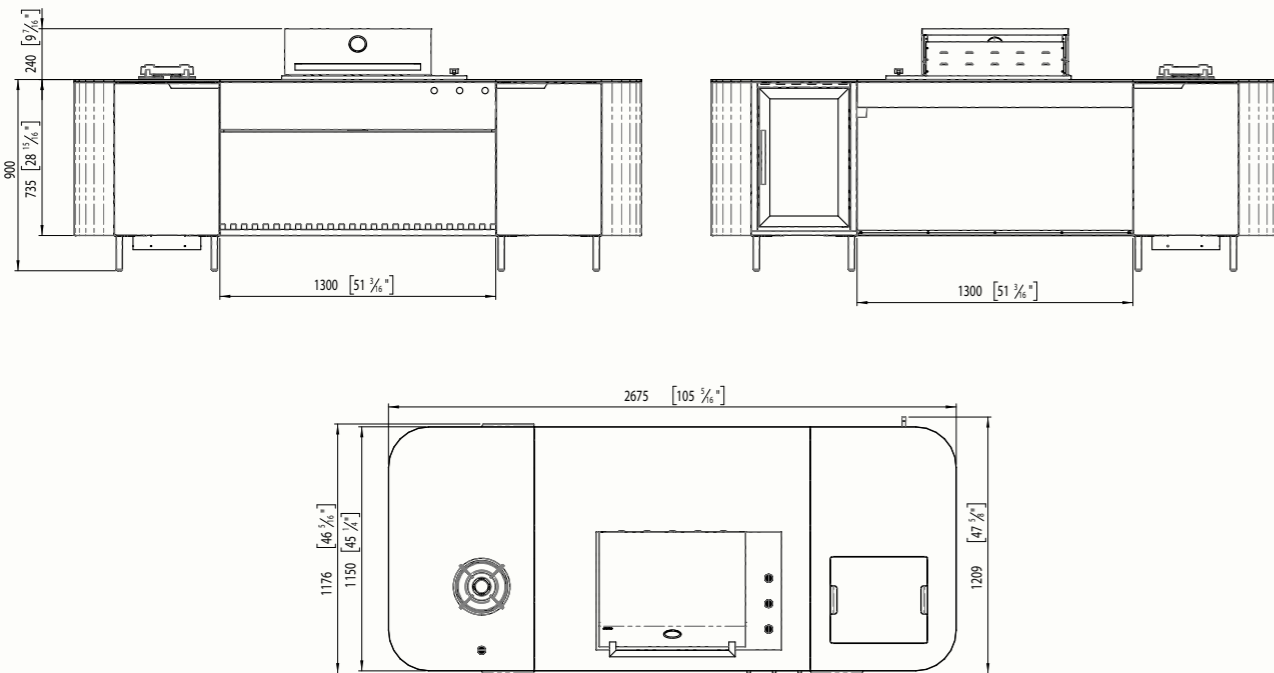

Outdoor Fireplaces

Designed to match your Q-boo kitchen

Enhance your outdoor cooking area with premium Planika fireplaces finished in Dekton, offered in three finishes. They add warmth and a welcoming atmosphere for memorable moments outdoors.

400cm STONE Collection (157 1/2")

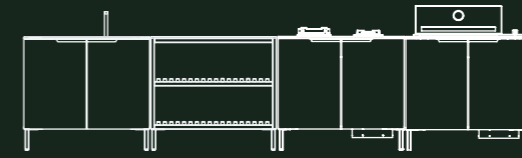

Sink module Open cabinet Double burner BBQ module



Galaxy Table



SEE THIS
CONFIGURATION IN AR



Gas Fireplaces

Dekton finish ensuring durability and architectural coherence

You can enhance your Q-boo kitchens with Planika gas fireplaces – compatible with the same bottle gas systems used in outdoor kitchens. Galaxy Table and Stella Table feature Dekton-finished surfaces and elegant design, providing precise flame control and cozy outdoor warmth.



SEE THIS
CONFIGURATION IN AR

350cm LINE Collection (137 13/16")

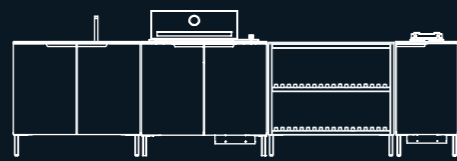

Sink module BBQ module Open cabinet Single burner 50



Galaxy Table

Gas Fireplaces

GALAXY TABLE



GALAXY

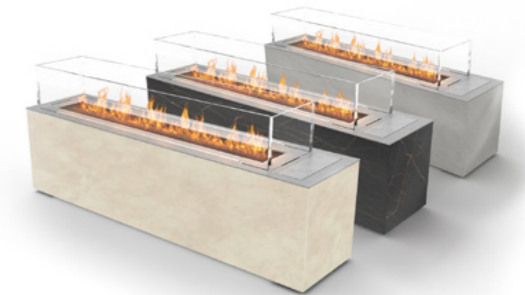

	GALAXY TABLE	GALAXY
Dimensions	WxHxD 1145 mm x 504 mm x 760 mm WxHxD 45.1" x 19.8" x 29.9"	WxHxD 1150 mm x 492 mm x 350 mm WxHxD 45.3" x 19.4" x 13.8"
Heat output		(NG) max. 10.1kW / 34 500 BTU/h (LPG) max. 13.4kW / 45 700 BTU/h
Gas Consumption		(NG) max. 0.96 m ³ /h / 33.9 ft ³ /h (LPG) max. 0.95 kg/h / 2.1 lbs/h
Gas Pressure		(NG) 20 mbar / 8.0 inWC (LPG) 37 mbar / 14.9 inWC

STELLA TABLE



	STELLA TABLE
Dimensions	WxHxD 954 mm x 388 mm x 954 mm WxHxD 37.6" x 15.3" x 37.6"
Heat output	(NG) max. 7.9 kW 32 420 BTU/h (LPG) max. 12.6 kW 34 120 BTU/h
Gas Consumption	(NG) max. 0.71 m ³ /h 30.0 ft ³ /h (LPG) max. 0.98 kg/h 1.72 lb/h
Gas Pressure	(NG) 20 mbar / 8.0 inWC (LPG) 37 mbar / 14.8 inWC

Ethanol fireplaces

Safe and clean combustion with elegant Dekton finish

Bring warmth and style to the Qboo kitchen design with Planika ethanol fireplaces, combining BEV® technology with premium Dekton surfaces. Models like Porto, Cabo Table, and Cabo fireplaces deliver warmth and a luxurious atmosphere for outdoor spaces.



Ethanol Fireplaces

CABO TABLE



CABO

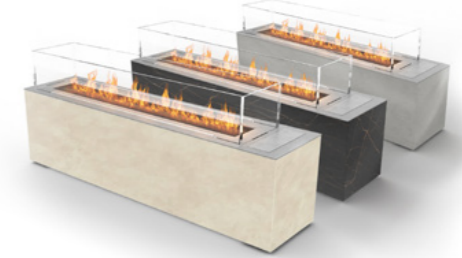

	CABO TABLE	CABO
Dimensions	WxHxD 1145 mm x 504 mm x 760 mm WxHxD 45.1" x 19.8" x 29.9"	WxHxD 1150 mm x 492 mm x 350 mm WxHxD 45.3" x 19.4" x 13.8"
Heat output	max. 9.4 kW / 32 100 BTU/h	
Burning time	max. 14 h	
Tank capacity	10.5 L / 2.77 gal	
Power supply	230V / 115 V (US)	

PORTO



COMET TABLE



	PORTO
Dimensions	WxHxD 400 mm x 1147 mm x 400 mm WxHxD 15.7" x 45.1" x 15.7"
Heat output	max. 9.4 kW / 32 100 BTU/h
Burning time	max. 14 h
Tank capacity	10.5 L / 2.77 gal
Power supply	230V / 115 V (US)

	PORTO
Dimensions	ØxH 1150 mm x 437 mm ØxH 15.7" x 45.1" x 15.7"
Heat output	max. 9.4 kW / 32 100 BTU/h
Burning time	max. 14 h
Tank capacity	10.5 L / 2.77 gal
Power supply	230V / 115 V (US)



SEE THIS CONFIGURATION IN AR

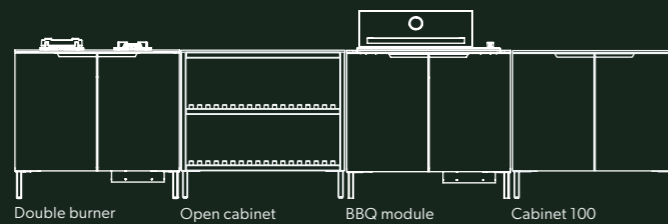

SEE THIS CONFIGURATION IN AR

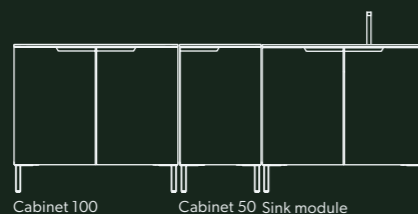

Porto



Cabo Table



Q-boo Design Team

Designing an outdoor kitchen involves more than picking modules.

Functionality, flow, and comfort all depend on smart planning — from **cooking zones** and **prep areas** to the **working triangle**.

Our design team is here to help you get it right. Whether you're designing for yourself or a client, **we can assist at every stage — from concept to execution.**

Use our online configurator to explore layouts, or let us build a custom setup with you.

We'll provide **2D drawings, 3D models, and full documentation** tailored to your space — so everything fits, works, and makes sense.

You can start on your own, or work directly with our team.

Either way, we're here to support your ideas and make them real.

CONTACT

www.q-boo.com

hello@q-boo.com



CONFIGURATOR

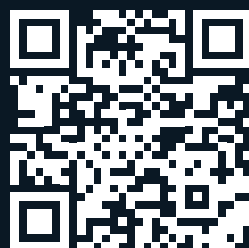

CONSULTATION FORM